



5 - OUTPUTS AND LED INDICATORS

5.1 - Status of the relay contacts

The following table shows the location of the relay contacts depending on the status of the detector (see table 4).

Table 4			
Detector status	Presence relay		Pulse relay
			
Free loop	closed	open	open
Occupied loop	open	closed	open
Loop is now free	closed	open	200 ms pulse
Loop fault	open	closed	open
Tension is off	closed	closed	open

In the event of loop faults, the detector will cyclically check the status of the loop and will automatically resume normal operation after the problem has been solved.

⚠ - Warning! On the card there are components which are sensitive to static energy. When working with the device open, appropriate precautions are required. Do not touch the components or conductors! The warranty will be nullified for damages caused by improper handling!

5.2 - LED indicators

The green LED indicates that the detector is ready for operation. The red LED, depending on the occupation status of the loop, indicates the activation of the relay output (see table 5).

Table 5		
Green LED loop control	Red LED loop status	Detector status
Off	Off	No power voltage
Flashing light	Off	Frequency indication or adjustment
On	Off	The detector is ready, free loop
On	On	The detector is ready, occupied loop
Off	On	Loop fault

5.3 - Loop frequency indication

About 1 s after the adjustment of the detector, the frequency of the loop is shown by the flashing green LED signal. First of all, the 10 kHz location of the frequency value will be displayed. For each frequency value of 10 kHz, the green LED of the detector channel will flash once. After 1 sec. the 1 kHz position will be displayed in the same manner. If the value at the position of 1 kHz is '0' the LED will flash 10 times. The 1 kHz position flashes are slightly shorter than the 10 kHz position flashes.

Example of 57 kHz loop frequency:

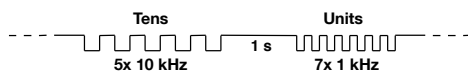

6 - ELECTRICAL CONNECTIONS

⚠ - Warning!

- Incorrect connections can cause faults or hazards; therefore ensure that the specified connections are strictly observed and performed by experienced and qualified personnel.

- Hook up the unit with the electrical power shut off.

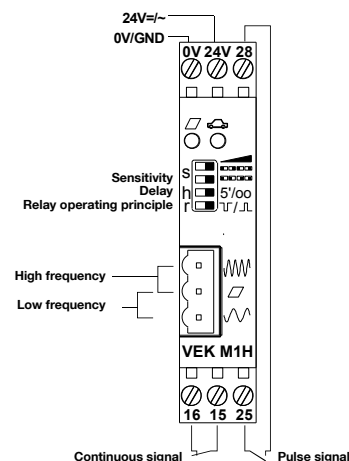

7 - DISPOSAL OF THE PRODUCT

This product constitutes an integral part of the automation system, therefore it must be disposed of together with it. As in installation, also at the end of product lifetime, the disassembly and scrapping operations must be performed by qualified personnel. This product is made up of different types of material, some of which can be recycled while others must be disposed of. Seek information on the recycling and disposal systems envisaged by the local regulations in your area for this product category. **⚠ - Some parts of the product may contain polluting or hazardous substances which, if disposed of into the environment, constitute serious environmental and health risks.**



As indicated by the symbol, the product may not be disposed of as domestic waste. Sort the materials for disposal, according to the methods envisaged by current legislation in your area, or return the product to the retailer when purchasing an equivalent product.

⚠ - Local legislation may include the application of serious fines in the event of improper disposal of this product.

8 - TECHNICAL SPECIFICATIONS

Note: • All technical specifications stated herein refer to an ambient temperature of 20° C (± 5° C). • Nice S.p.A. reserves the right to apply modifications to products at any time when deemed necessary, maintaining the same intended use and functionality.

• **Dimensions:** 79 x 22.5 x 90 mm (H x W x L without plug) • **Protection type:** IP40 • **Power supply:** 24 V ~ / ±10 % max.1.5 W • **Operation temperature:** -20°C to +70°C • **Air humidity:** max 95% with no condensation • **Loop inductivity:** 25-800 µH, recommended 100-300 µH • **Frequency range:** 26-130 kHz in 2 steps • **Sensitivity:** from 0.01% to 0.64% (Δf/f) in 4 levels - from 0.02% to 1.3% (ΔL/L) • **Delay:** 5 min or uninterrupted • **Electric power line of the loop:** max. 250 m • **Loop resistance:** max. 20 Ohm (including power line) • **Relay:** 250 mA / 24 V ~ / ± (min.1 mA/5 V) • **Energise delay:** normally 100 ms • **Signal duration:** > 200 ms • **De-energise delay:** normally 40 ms • **Connection:** Screw terminals (power supply, relay) – Snap-on terminal clamps (loops connection)

Nice
LP21

CE EN

User, installation and safety instructions

Nice

ISO425A00MM_04-11-2016

Nice

Nice S.p.A.
Via Pezza Alta, 13
31046 Oderzo TV Italy
info@niceforyou.com

www.niceforyou.com

1 - GENERAL WARNINGS: SAFETY - INSTALLATION - USE

(Instructions translated from Italian)

CAUTION Important safety instructions. Follow all instructions as improper installation may cause serious damage

CAUTION Important safety instructions. It is important for you to comply with these instructions for your own and other people's safety. Keep these instructions

- Before commencing the installation, check the "Product technical specifications", in particular whether this product is suitable for automating your guided part. If it is not suitable, DO NOT continue with the installation
- Before proceeding with the installation of the product, check that all materials are in good working order and suited to the intended applications
- The product is not intended for use by persons (including children) with reduced physical, sensory or mental capacities, nor by anyone with insufficient experience or familiarity
- Children must not play with the appliance
- Do not allow children to play with the control devices of the product

CAUTION In order to avoid any danger from inadvertent resetting of the thermal cut-off device, this appliance must not be powered through an external switching device, such as a timer, or connected to a supply that is regularly powered or switched off by the circuit

- Provide a disconnection device (not supplied) in the plant's mains power supply, with a contact opening distance that permits complete disconnection under the conditions dictated by over-voltage category III
- Handle the product with care during installation, taking care to avoid crushing, denting or dropping it, or allowing contact with liquids of any kind. Keep the product away from sources of heat and naked flames. Failure to observe the above can damage the product, and increase the risk of danger or malfunction. If this should happen, stop installation immediately and contact Customer Service
- The manufacturer assumes no liability for damage to property, items or persons resulting from non-compliance with the assembly instructions. In such cases the warranty for material defects is excluded
- Before working on the system (maintenance, cleaning), always disconnect the product from the mains power supply
- The packing materials of the product must be disposed of in compliance with local regulations
- If the product is damaged do not try to fix it and please contact the Service Centre

2 - PRODUCT DESCRIPTION AND INTENDED USE

- Barrier controls
- Gate and door controls
- Parking and traffic managing

⚠ Warning! All uses other than the described use and use in environmental conditions other than those indicated in this manual should be considered improper and forbidden!

3 - FUNCTIONAL SPECIFICATIONS

The LP21 inductive loop detector is a system used for detecting vehicles by means of inductive loops with the following characteristics:

- Galvanic isolation between loop and electronic parts of the detector
- Automatic adjustment of the system after power up
- Continuous balancing of frequency drift
- Suitable for monitoring individual parking spaces
- Sensitivity can be set regardless of the loop inductivity
- Occupied loop message reported by the LED indicator
- Relay 0V contacts for continuous signal and pulse signal
- Output pulse signal from the loop
- Indication of the loop frequency via LED
- Loop connection available for Diagnostics

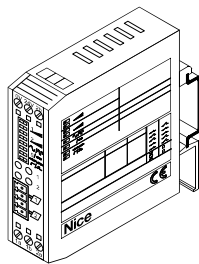

In the design and installation of inductive loops, you should take into consideration the table opposite.

A normal insulated copper wire, preferably with a cross-section of 1.5 mm², can be used to create the loop.

Lay the cable, with the number of windings indicated in the table. The two cable ends must be intertwined (at least 20 times per meter) from the loop to the detector.

Table	
Loop perimeter	number of windings
less than 3 m.	6
from 3 to 4 m.	5
from 4 to 6 m.	4
from 6 to 12 m.	3
over 12 m.	2

4 - PROGRAMMING

4.1 - Sensitivity

The sensitivity setting determines the change in frequency that a vehicle must cause in order to use the output of the detector. The sensitivity setting can be adjusted on 4 levels by means of the two DIP Switch 's' located in the front part of the loop detector (see table 1).

Table 1		
Sensitivity level		"s" DIP Switch
1 low	(0.64 % Δf/f)	
2	(0.16 % Δf/f)	
3	(0.04 % Δf/f)	
4 high	(0.01 % Δf/f)	

4.2 - Delay and reset

The delay can be set with the 'h' DIP Switch.

After the delay time has elapsed, a message indicating "loop unoccupied" is displayed and a new recalibration of the loop is started automatically. The delay starts when the loop is occupied (see table 2).

Table 2	
Delay	"h" DIP Switch
5 minutes	5'/∞
Uninterrupted	5'/∞

When switching on the power supply voltage, the detector will adjust the loop frequency. If there are brief outages in voltage (< 0.1 s), no new adjustment will take place.

A reset with a new adjustment can be activated manually by changing the delay time.

4.3 - Operating principle of the presence relays

The presence signal and the pulse signal of the detector are both provided with a 0V contact relay. The operating principle of the relay for the presence signal can be selected with the 'r' DIP Switch (see table 3).

Table 3	
Delay	"r" DIP Switch
When the signal is sent, the relay coil is energised and the contact opens	
When the signal is sent, the relay coil is de-energised and the contact closes	

4.4 - Frequency setting

The operating frequency of the detector can be set at 2 levels on the 3-pole front terminal block. The permitted frequency range is between 30 kHz and 130 kHz. The frequency depends on the chosen frequency level, and the inductivity resulting from the geometry of the loop, the number of windings on the loop and the loop's power supply line.

up = high frequency

down = low frequency

Installation examples

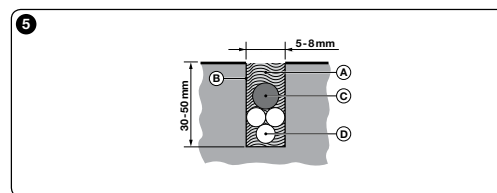
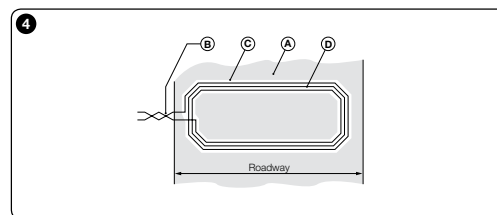
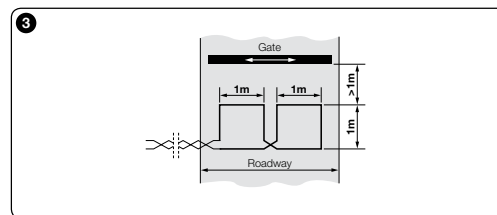
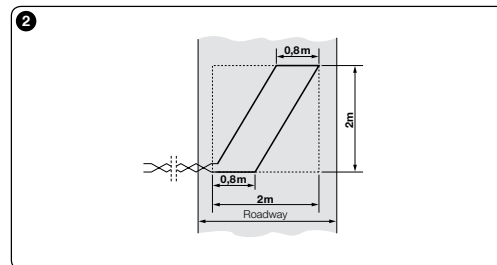
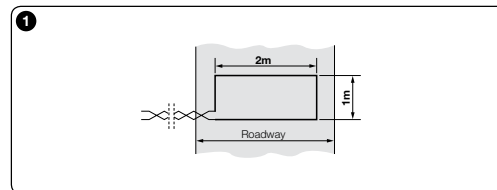

Fig. 1 - Recommended for cars, lorries, buses

Fig. 2 - Recommended for motorbikes and bicycles

Fig. 3 - Applications requiring low sensitivity at the side

Fig. 4 - (A) Floor (B) Twisted wire (C) Groove (D) Loops

Fig. 5 - (A) Sealant (B) Groove (C) Twine (D) Loops